

PNP Silicon Darlington Transistors

- High collector current
- High DC current gain

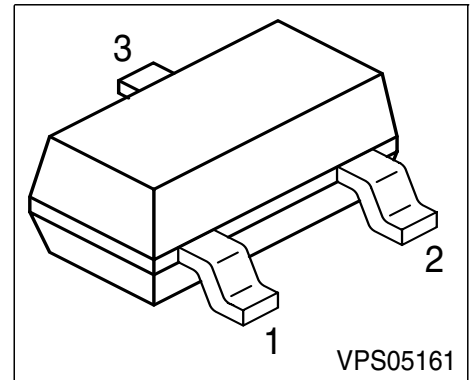

Type	Marking	Pin Configuration			Package
SMBTA64	s2V	1 = B	2 = E	3 = C	SOT23

Maximum Ratings

Parameter	Symbol	Value	Unit
Collector-emitter voltage	V_{CES}	30	V
Collector-base voltage	V_{CBO}	30	
Emitter-base voltage	V_{EBO}	10	
DC collector current	I_C	500	mA
Peak collector current	I_{CM}	800	A
Base current	I_B	100	mA
Peak base current	I_{BM}	200	
Total power dissipation, $T_S = 81\text{ °C}$	P_{tot}	330	mW
Junction temperature	T_j	150	°C
Storage temperature	T_{stg}	-65 ... 150	

Thermal Resistance

Junction - soldering point ¹⁾	R_{thJS}	≤210	K/W
--	------------	------	-----

¹⁾For calculation of R_{thJA} please refer to Application Note Thermal Resistance

Electrical Characteristics at $T_A = 25^\circ\text{C}$, unless otherwise specified.

Parameter	Symbol	Values			Unit
		min.	typ.	max.	
DC Characteristics					
Collector-emitter breakdown voltage $I_C = 10 \mu\text{A}, V_{BE} = 0$	$V_{(BR)CES}$	30	-	-	V
Collector-base breakdown voltage $I_C = 10 \mu\text{A}, I_E = 0$	$V_{(BR)CBO}$	30	-	-	
Emitter-base breakdown voltage $I_E = 10 \mu\text{A}, I_C = 0$	$V_{(BR)EBO}$	10	-	-	
Collector cutoff current $V_{CB} = 30 \text{ V}, I_E = 0$	I_{CBO}	-	-	100	nA
Collector cutoff current $V_{CB} = 30 \text{ V}, I_E = 0, T_A = 150^\circ\text{C}$	I_{CBO}	-	-	10	μA
Emitter cutoff current $V_{EB} = 10 \text{ V}, I_C = 0$	I_{EBO}	-	-	100	nA
DC current gain 1) $I_C = 10 \text{ mA}, V_{CE} = 5 \text{ V}$ $I_C = 100 \text{ mA}, V_{CE} = 5 \text{ V}$	h_{FE}	10000 20000	- -	- -	-
Collector-emitter saturation voltage 1) $I_C = 100 \text{ mA}, I_B = 0.1 \text{ mA}$	V_{CEsat}	-	-	1.5	V
Base-emitter saturation voltage 1) $I_C = 100 \text{ mA}, I_B = 0.1 \text{ mA}$	V_{BEsat}	-	-	2	
AC Characteristics					
Transition frequency $I_C = 50 \text{ mA}, V_{CE} = 5 \text{ V}, f = 20 \text{ MHz}$	f_T	125	-	-	MHz

 1) Pulse test: $t \leq 300 \mu\text{s}$, $D = 2\%$

Total power dissipation $P_{tot} = f(T_S)$

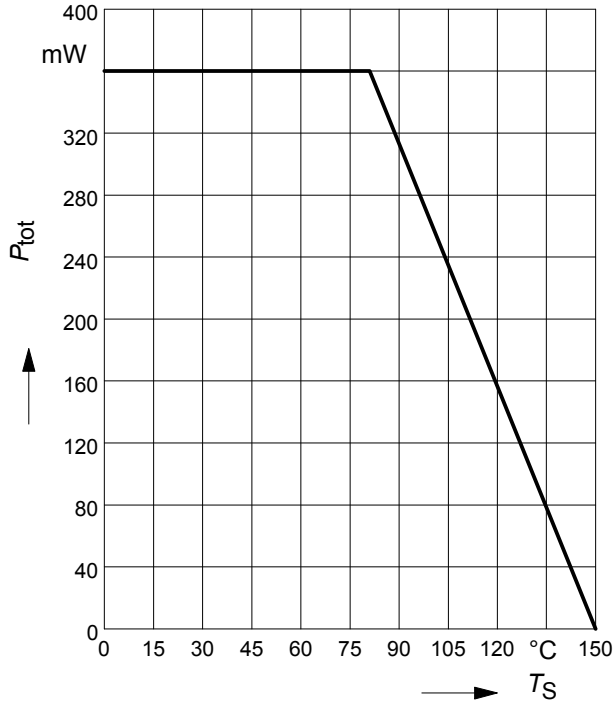

**Collector-base capacitance $C_{CB} = f(V_{CB0})$
Emitter-base capacitance $C_{EB} = f(V_{EB0})$**

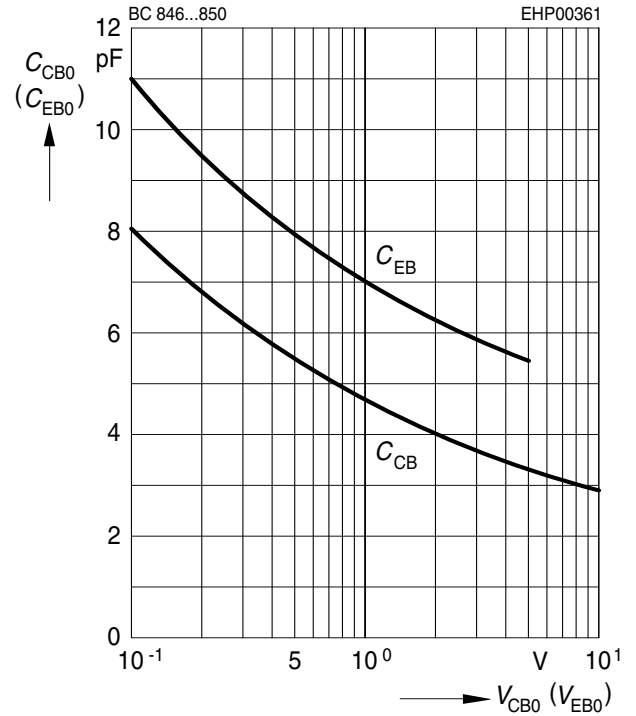

Permissible pulse load

$P_{totmax} / P_{totDC} = f(t_p)$

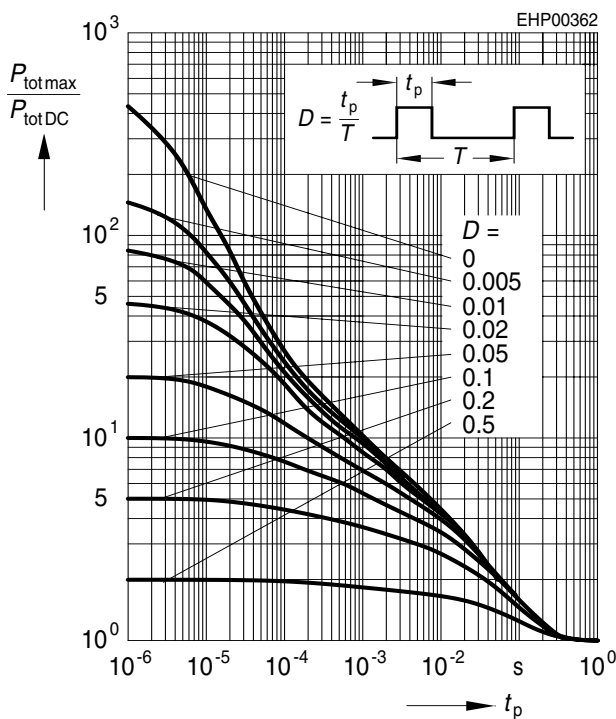

Transition frequency $f_T = f(I_C)$

$V_{CE} = 5V$

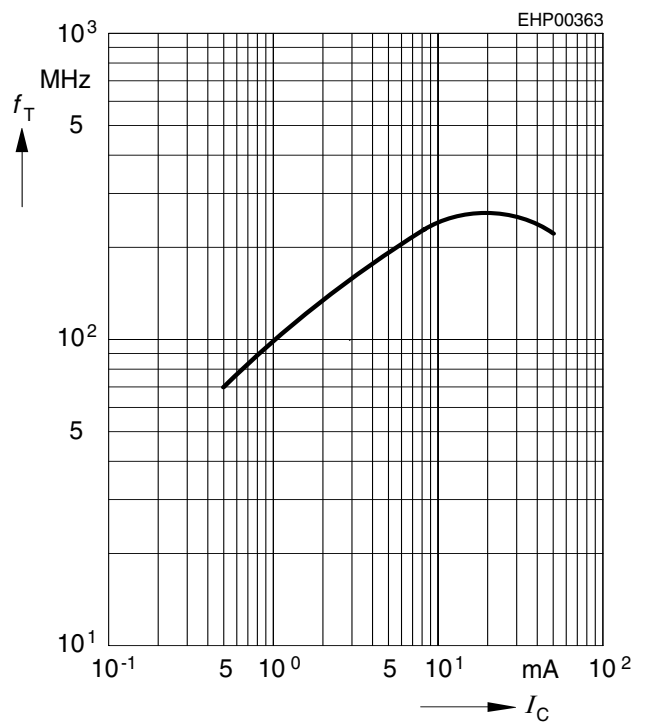

Base-emitter saturation voltage

$I_C = f(V_{BEsat}), h_{FE} = 20$

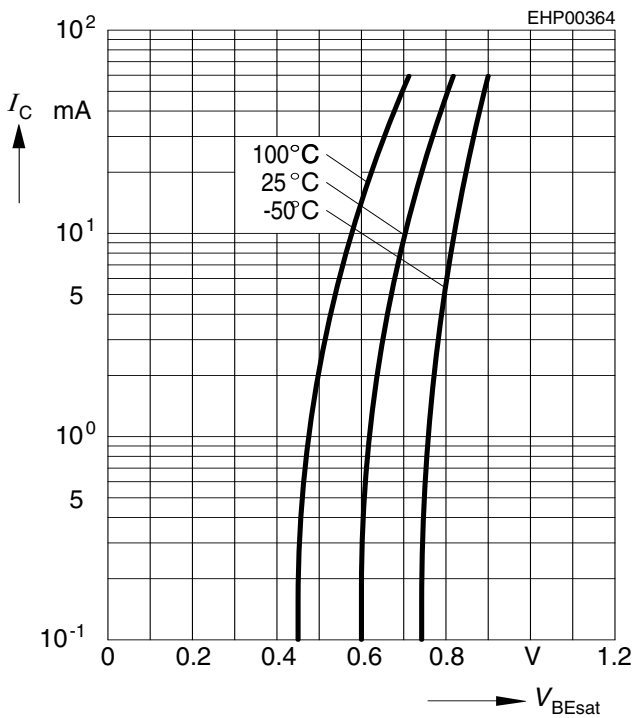

Collector-emitter saturation voltage

$I_C = f(V_{CEsat}), h_{FE} = 20$

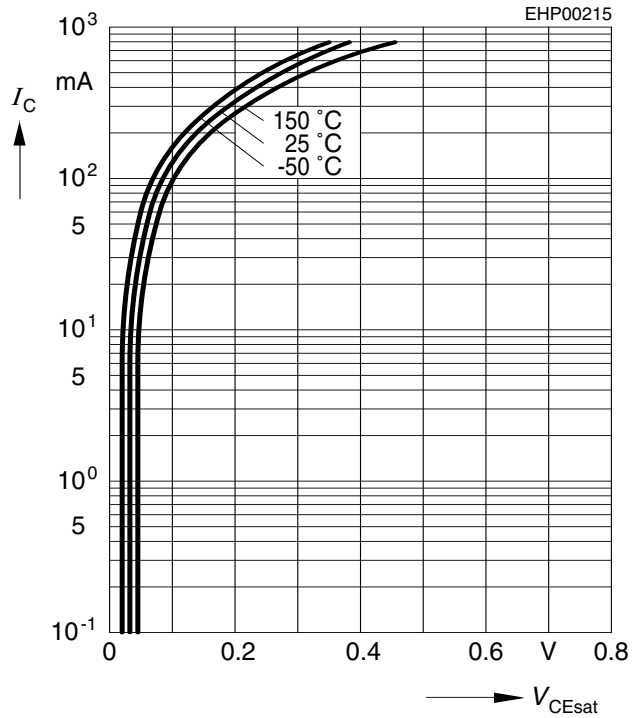

Collector cutoff current $I_{CBO} = f(T_A)$

$V_{CB} = 30V$

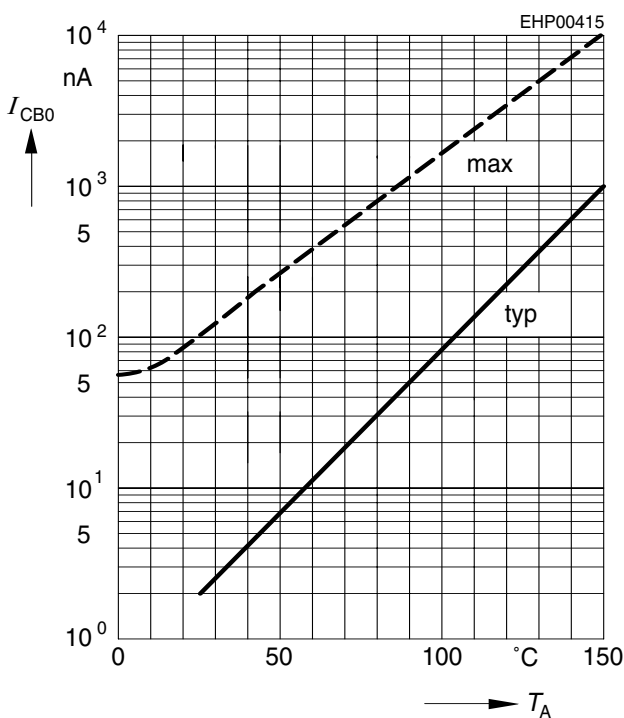

DC current gain $h_{FE} = f(I_C)$

$V_{CE} = 5V$

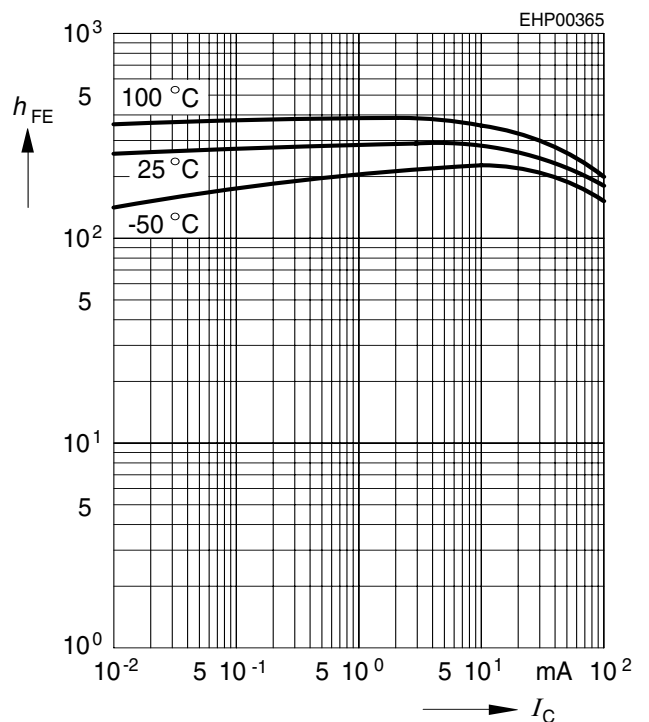

Package Outline

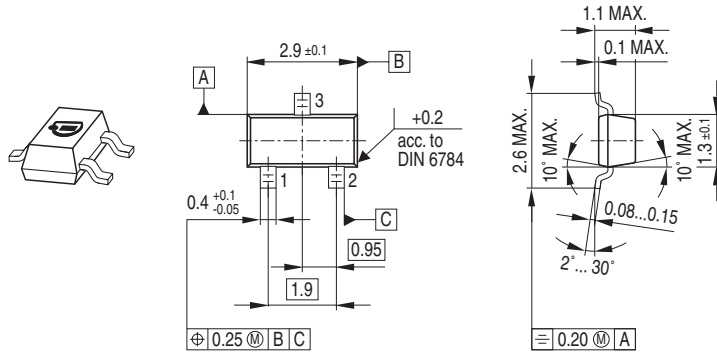

Foot Print

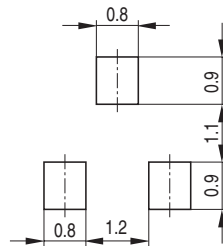

Marking Layout

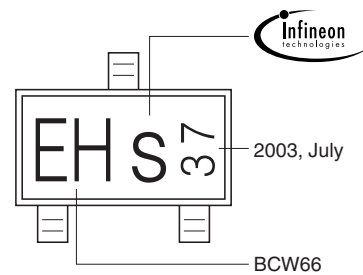
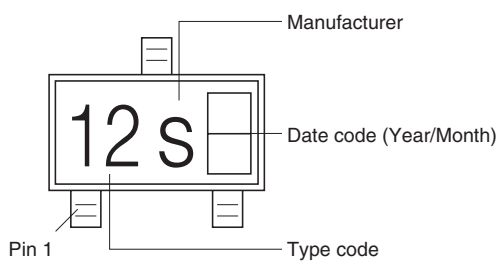

Example

Packing

Code E6327: Reel \varnothing 180 mm = 3.000 Pieces/Reel

Code E6433: Reel \varnothing 330 mm = 10.000 Pieces/Reel

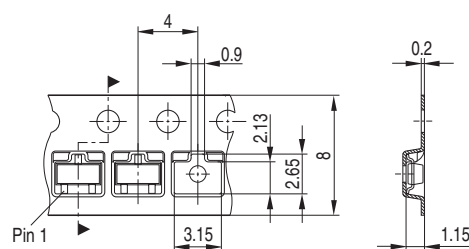

Published by Infineon Technologies AG,
St.-Martin-Strasse 53,
81669 München
© Infineon Technologies AG 2005.
All Rights Reserved.

Attention please!

The information herein is given to describe certain components and shall not be considered as a guarantee of characteristics.

Terms of delivery and rights to technical change reserved.

We hereby disclaim any and all warranties, including but not limited to warranties of non-infringement, regarding circuits, descriptions and charts stated herein.

Information

For further information on technology, delivery terms and conditions and prices please contact your nearest Infineon Technologies Office (www.infineon.com).

Warnings

Due to technical requirements components may contain dangerous substances. For information on the types in question please contact your nearest Infineon Technologies Office.

Infineon Technologies Components may only be used in life-support devices or systems with the express written approval of Infineon Technologies, if a failure of such components can reasonably be expected to cause the failure of that life-support device or system, or to affect the safety or effectiveness of that device or system. Life support devices or systems are intended to be implanted in the human body, or to support and/or maintain and sustain and/or protect human life. If they fail, it is reasonable to assume that the health of the user or other persons may be endangered.